

Tech Sheet: Cessna T-50 Bobcat "Bamboo Bomber"

(cessna-T50.pdf)

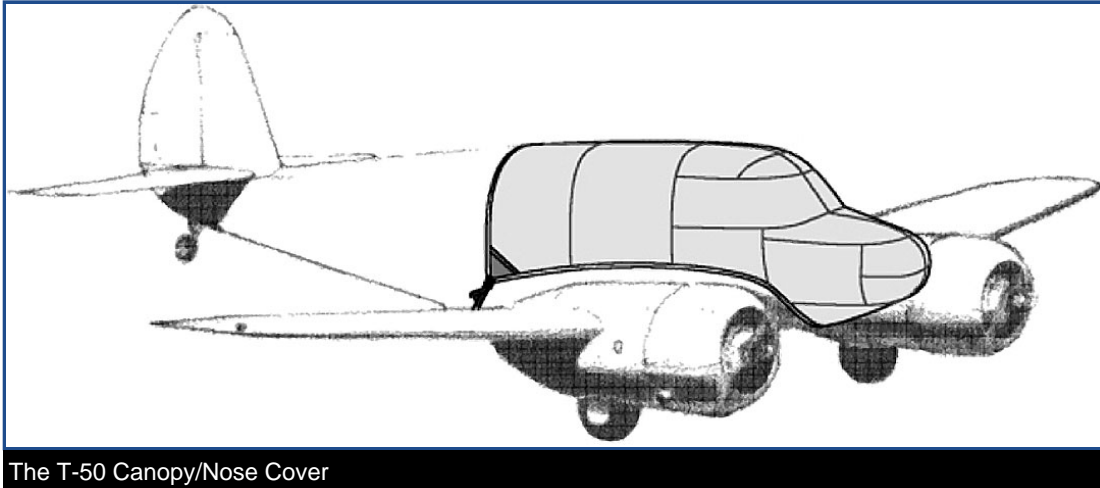

The T-50 Canopy/Nose Cover

Section 1: Canopy/Cockpit/Fuselage Covers

The **Canopy/Nose Cover** combines a Canopy Cover and a Nose cover. The Cessna T-50 Bobcat "Bamboo Bomber" Canopy/Nose Cover is designed to enclose the windshield, all side windows, canopy roof, and also extends forward to cover the nose. It is a one-piece cover. The Canopy/Nose Cover is custom designed for each model, as well as your aircraft's specific antenna and temperature probe placements. The Canopy/Nose Cover attaches using adjustable "belly straps", which run under the belly and connect to the other side of the cover with a quick-release plastic buckle. To ensure the most secure fit, high-quality shock cord is enclosed in the hem of the cover to help keep the cover tighter against the airplane. Canopy Covers are commonly referred to as Cabin Covers, Fuselage Covers, Canvas Covers, Canopy Caps, etc.

This cover type is made from Silver Acrylic Sunbrella canvas and is 100% lined with a soft and smooth microfiber. Bruce's Custom Covers developed this material combination especially for aircraft protection. The outer material is medium weight and treated for water resistance, UV resistance and anti-static buildup. The inner lining is a very soft and smooth microfiber to prevent scratching. The material is very reflective, and tests show that the cabin interior temperature can be reduced to near-ambient temperature on the hottest of days. It is water, ice and snow repellent, yet breathable to allow moisture to escape from between the cover and the aircraft surface.

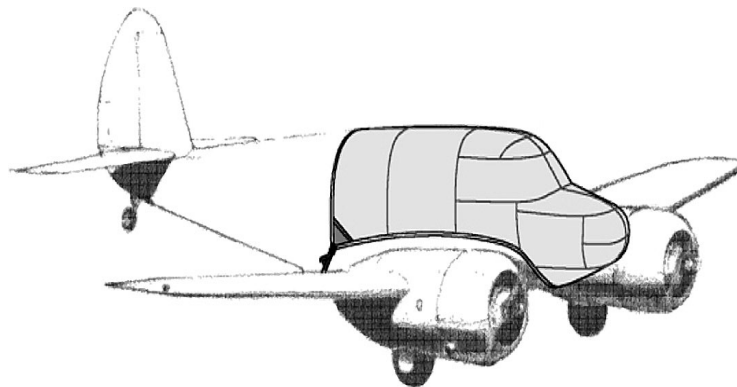

The T-50 Canopy/Nose Cover

Description	Part Number	Price
CANOPY/NOSE COVER	T50-000	\$955.00

Section 2: Engine/Prop Covers

Engine Covers will cinch around or behind the spinner, cover the entire engine cowl area including the engine air cooling and induction air inlets, and fastens together with Velcro beneath the spinner down the front of the cowling. The Engine Cover is attached with a belly strap aft of the firewall, and can Velcro to the Canopy Cover. Engine Covers are normally made from Solution-Dyed Polyester or Acrylic *Sunbrella*. An Insulated version of the engine cover can be made with a thicker, quilted, and water-repellent material. The Insulated Engine Cover works well in cold climates to help with engine preheating.

The **Cessna T-50 Bobcat "Bamboo Bomber" Insulated Engine Cover** works well in cold climates to help with engine preheating. You can add an access flap for an additional fee. It will cinch around or behind the spinner, cover the entire engine cowl area including the engine air inlets, and fastens together with Velcro beneath the spinner down the front of the cowling.

Insulated Covers Material - A special composite material of solution-dyed polyester, 3M Thinsulate insulation, and soft nylon interior fabric. Our insulated covers are designed to complement an engine preheater and help retain heat in the engine compartment after shutdown. If you operate your aircraft in cold-weather, these covers will help prevent engine wear and tear.

The **Cessna T-50 Bobcat "Bamboo Bomber" Propeller Cover** is a one-piece design that form fits to the blades and spinner. The prop cover slips over the blades and spinner and is attached by a plastic all-weather zipper on the bottom of the blades. Propeller covers can be made for multiple numbers of blades, and for wooden, composite or metal props. The Propeller Cover is normally made from Acrylic *Sunbrella* or Solution-Dyed Polyester and is lined 100% with a soft and smooth microfiber. **Insulated Propeller Covers** works well in cold climates to help with engine preheating. These insulated versions are made with a thicker, quilted, water-repellent, and breathable material.

This cover type is made from Silver Acrylic Sunbrella canvas and is 100% lined with a soft and smooth microfiber. Bruce's Custom Covers developed this material combination especially for aircraft protection. The outer material is medium weight and treated for water resistance, UV resistance and anti-static buildup. The inner lining is a very soft and smooth microfiber to prevent scratching. The material is very reflective, and tests show that the cabin interior temperature can be reduced to near-ambient temperature on the hottest of days. It is water, ice and snow repellent, yet breathable to allow moisture to escape from between the cover and the aircraft surface.

Description	Part Number	Price
ENGINE COVERS (set of 2)	T50-110	\$945.00
INSULATED ENGINE COVERS (set of 2)	T50-115	\$1810.00
PROPELLOR/SPINNER COVERS, 2 blade	T50-120	\$590.00
INSULATED PROPELLOR/SPINNER COVERS, 2 blade	T50-125	\$890.00
PROPELLOR/SPINNER COVERS, 3 blade	T50-130	\$800.00
INSULATED PROPELLOR/SPINNER COVERS, 3 blade	T50-135	\$1145.00

Section 6: Miscellaneous Products

Description	Part Number	Price
ENGINE GAP SEALS (set of 2)	T50-100	\$285.00

Prices subject to change. Other Covers and Design Alterations: Prices on request.
Prices are FOB Morgan Hill, CA. Sales tax on orders shipped to California addresses. Orders take approximately 3 weeks to complete. For domestic orders we normally ship by UPS ground service. Next day shipping and air parcel post is

available on request. We can take payment by Visa, Mastercard, American Express, or Discover.

Bruce's Custom Covers offers protective covers and plugs for virtually every type of airplane, jet and helicopter. If you have questions about our products please call any time TOLL FREE: 800/777-6405, or FAX: 408/738-2729.

Instructions: Measure to the nearest 1/8" and only fill in what applies. You may email, fax or phone in the measurements.

Aircraft Reg / Tail Number: _____ Aircraft Type: _____ Year: _____
 Name: _____ Phone & Email: _____

OAT Placement

A	From top of windshield						
B	Offset from centerline						
	<table style="width: 100%; border-collapse: collapse;"> <tr> <td style="width: 33%; text-align: center;">Left</td> <td style="width: 33%; text-align: center;">Center</td> <td style="width: 33%; text-align: center;">Right</td> </tr> <tr> <td style="text-align: center;"><small>(pilot)</small></td> <td></td> <td style="text-align: center;"><small>(co-pilot)</small></td> </tr> </table>	Left	Center	Right	<small>(pilot)</small>		<small>(co-pilot)</small>
Left	Center	Right					
<small>(pilot)</small>		<small>(co-pilot)</small>					
C	Height						
D	From FWD edge						
E	From lower edge						
F	From forward corner						
G	Distance forward						



Antenna Placements	Example <small>(inches or metric)</small>	Antenna #1			Antenna #2			Antenna #3			Antenna #4																								
H Distance from top center windshield to front of Antenna	34 5/8"																																		
J Length/Width of Antenna base	5 1/2" x 3 1/4"																																		
K Offset from Centerline	9 1/2"																																		
Antenna Offset (mark one)	<table style="width: 100%; border-collapse: collapse;"> <tr> <td style="width: 33%; text-align: center;">Left</td> <td style="width: 33%; text-align: center;">Center</td> <td style="width: 33%; text-align: center;">Right</td> </tr> <tr> <td style="text-align: center;"><small>(pilot)</small></td> <td style="text-align: center;">X</td> <td style="text-align: center;"><small>(co-pilot)</small></td> </tr> </table>	Left	Center	Right	<small>(pilot)</small>	X	<small>(co-pilot)</small>	<table style="width: 33%; border-collapse: collapse;"> <tr> <td style="width: 33%; text-align: center;">Left</td> <td style="width: 33%; text-align: center;">Center</td> <td style="width: 33%; text-align: center;">Right</td> </tr> <tr> <td style="text-align: center;"><small>(pilot)</small></td> <td></td> <td style="text-align: center;"><small>(co-pilot)</small></td> </tr> </table>	Left	Center	Right	<small>(pilot)</small>		<small>(co-pilot)</small>	<table style="width: 33%; border-collapse: collapse;"> <tr> <td style="width: 33%; text-align: center;">Left</td> <td style="width: 33%; text-align: center;">Center</td> <td style="width: 33%; text-align: center;">Right</td> </tr> <tr> <td style="text-align: center;"><small>(pilot)</small></td> <td></td> <td style="text-align: center;"><small>(co-pilot)</small></td> </tr> </table>	Left	Center	Right	<small>(pilot)</small>		<small>(co-pilot)</small>	<table style="width: 33%; border-collapse: collapse;"> <tr> <td style="width: 33%; text-align: center;">Left</td> <td style="width: 33%; text-align: center;">Center</td> <td style="width: 33%; text-align: center;">Right</td> </tr> <tr> <td style="text-align: center;"><small>(pilot)</small></td> <td></td> <td style="text-align: center;"><small>(co-pilot)</small></td> </tr> </table>	Left	Center	Right	<small>(pilot)</small>		<small>(co-pilot)</small>	<table style="width: 33%; border-collapse: collapse;"> <tr> <td style="width: 33%; text-align: center;">Left</td> <td style="width: 33%; text-align: center;">Center</td> <td style="width: 33%; text-align: center;">Right</td> </tr> <tr> <td style="text-align: center;"><small>(pilot)</small></td> <td></td> <td style="text-align: center;"><small>(co-pilot)</small></td> </tr> </table>	Left	Center	Right	<small>(pilot)</small>		<small>(co-pilot)</small>
Left	Center	Right																																	
<small>(pilot)</small>	X	<small>(co-pilot)</small>																																	
Left	Center	Right																																	
<small>(pilot)</small>		<small>(co-pilot)</small>																																	
Left	Center	Right																																	
<small>(pilot)</small>		<small>(co-pilot)</small>																																	
Left	Center	Right																																	
<small>(pilot)</small>		<small>(co-pilot)</small>																																	
Left	Center	Right																																	
<small>(pilot)</small>		<small>(co-pilot)</small>																																	
L Slope length of Antenna (types 1-3 only)	18"																																		
M Antenna Type (see types below)	1																																		



Instructions: Measure to the nearest 1/8" and only fill in what applies. You may email, fax or phone in the measurements.

Aircraft Reg / Tail Number: _____ Aircraft Type: _____ Year: _____
 Name: _____ Phone & Email: _____

Propellor Measurements

Please check one:	2 - Blade	3 - Blade	4 - Blade
A Measure along surface of cone			
B Measure "straight line" base to tip			
C Base to top of blade root opening			
D Provide diameter or circumference			
E Provide diameter or circumference			
F Blade root to prop tip			
G Trailing edge to leading edge			
H Trailing edge to leading edge			
J Trailing edge to leading edge			

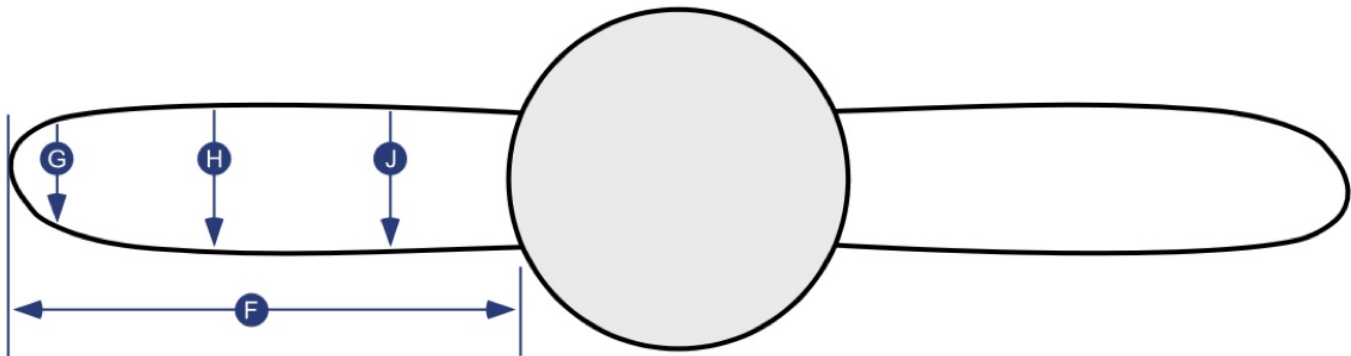
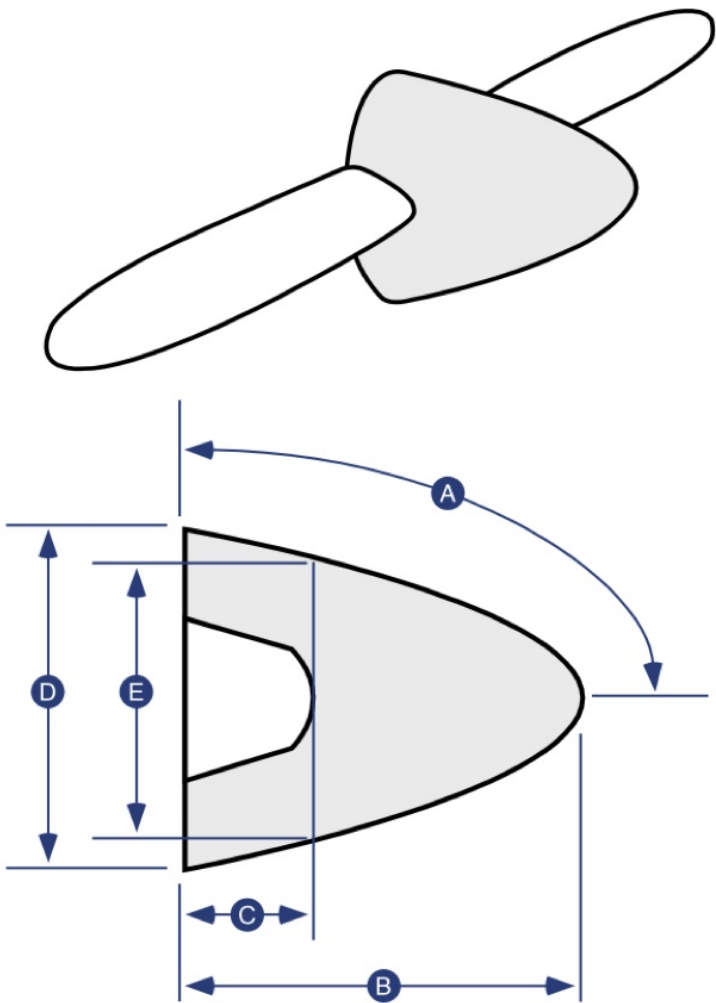

Ph: 408/738-3959 • Toll Free: 800/777-6405 • Fax: 408/738-2729 • bruce@aircraftcovers.com